

Dimensions of SH Series

SH-AN (High load type)

SH-BN (Super high load type)

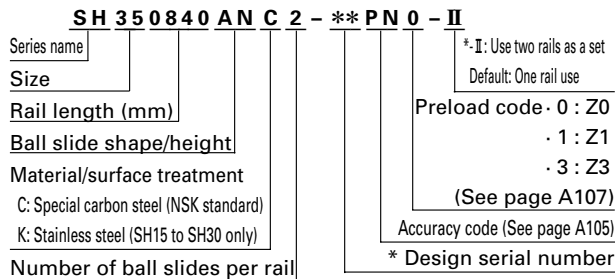

* Please note that we assign the design number, and omit the last code (II) that indicates a use of two rails as a set to finalize the reference number as product identification.

Front view of AN and BN types

Side view of AN type

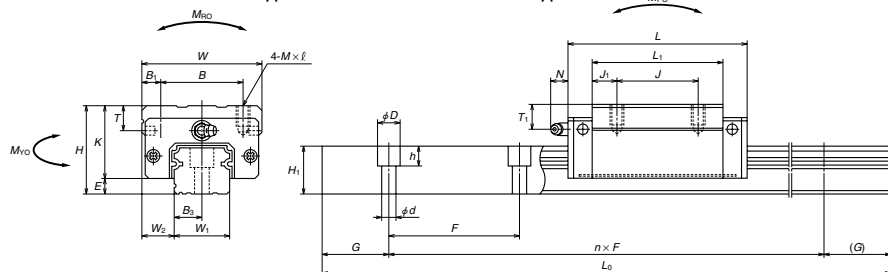

Side view of BN type

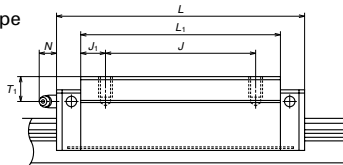

Model No.	Assembly			Ball slide												
	Height	Width	Length	Mounting hole					Grease fitting							
				H	E	W ₂	W	L	B	J	Mxpitchxℓ	B ₁	L ₁	J ₁	K	T
SH15AN SAH15AN SH15BN SAH15BN	28	4.6	9.5	34	55 74	26	26	M4x0.7x6	4	39 58	6.5 16	23.4	8	φ3	8.5	3.3
SH20AN SAH20AN SH20BN SAH20BN	30	5	12	44	69.8 91.8	32	36 50	M5x0.8x6	6	50 72	7 11	25	12	M6x0.75	5	11
SH25AN SAH25AN SH25BN SAH25BN	40	7	12.5	48	79 107	35	35 50	M6x1x9	6.5	58 86	11.5 18	33	12	M6x0.75	10	11
SH30AN SAH30AN SH30BN SAH30BN	45	9	16	60	85.6 124.6	40	40 60	M8x1.25x10	10	59 98	9.5 19	36	14	M6x0.75	10	11
SH35AN SAH35AN SH35BN SAH35BN	55	9.5	18	70	109 143	50	50 72	M8x1.25x12	10	80 114	15 21	45.5	15	M6x0.75	15	11
SH45AN SAH45AN SH45BN SAH45BN	70	14	20.5	86	139 171	60	60 80	M10x1.5x17	13	105 137	22.5 28.5	56	17	Rc1/8	20	13
SH55AN SAH55AN SH55BN SAH55BN	80	15	23.5	100	163 201	75	75 95	M12x1.75x18	12.5	126 164	25.5 34.5	65	18	Rc1/8	21	13

Reference number for rail of interchangeable types

For regular rails (non-jointed rail)

Example:

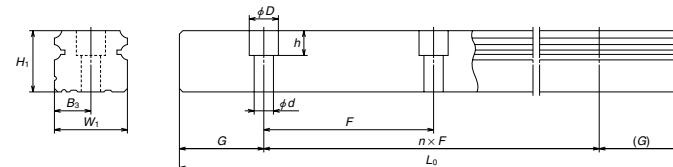
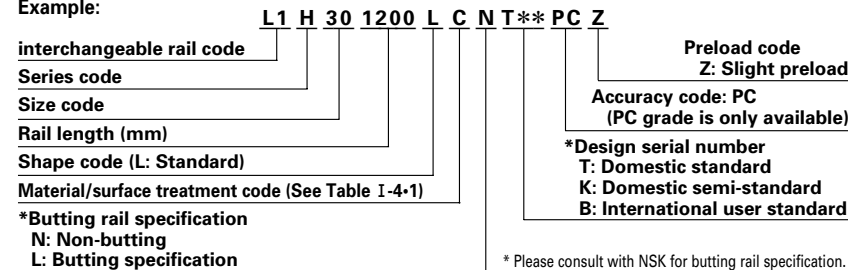

Reference number for ball slide of interchangeable types

Example:

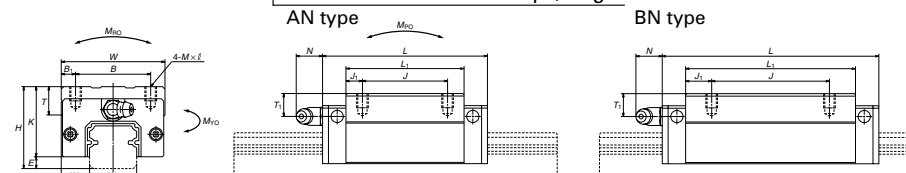
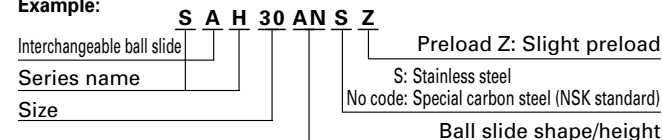

Rail							Basic load rating					Ball diameter	Weight	
Width	Height	Pitch	Mounting bolt hole	G	Max. length	Dynamic	Static	Static moment			D _w	Ball slide	Rail	
W ₁	H ₁	F	d x D x h	B ₃	L _{0max}			C	C ₀	M _{Ro}				M _{PO}
15	15	60	4.5x7.5x5.3	7.5	2 000 (1 800)	10 100 13 400	18 800 28 200	98 147	87 193	73 162	3.175	0.18 0.26	1.6	
20	18	60	6x9.5x8.5	10	20	3 960 (3 500)	16 300 21 600	29 600 44 500	199 298	167 360	141 305	3.968	0.33 0.48	2.6
23	22	60	7x11x9	11.5	20	3 960 (3 500)	22 400 32 000	37 500 62 500	295 490	246 615	207 515	4.762	0.55 0.82	3.6
28	26	80	9x14x12	14	20	4 000 (3 500)	31 000 46 000	51 500 91 500	490 870	365 1 060	305 885	5.556	0.77 1.3	5.2
34	29	80	9x14x12	17	20	4 000	47 500 61 500	80 500 117 000	950 1 380	780 1 600	655 1 340	6.35	1.5 2.1	7.2
45	38	105	14x20x17	22.5	22.5	3990	76 500 94 500	128 000 175 000	1 970 2 680	1 550 2 760	1 300 2 320	7.937	3.0 3.9	12.3
53	44	120	16x23x20	26.5	30	3960	113 000 140 000	181 000 247 000	3 300 4 550	2 640 4 800	2 210 4 050	9.525	4.7 6.1	16.9

The basic dynamic load rating is a load that furnishes 50 km rating fatigue life; it is a vertical and constant load to the ball slide mounting surface. When converting the basic dynamic load rating C to the dynamic load rating C₁₀₀ for 100 km rating fatigue life, divide the C by 1.26

SH-AL (High load type)
SH-BL (Super high load type)

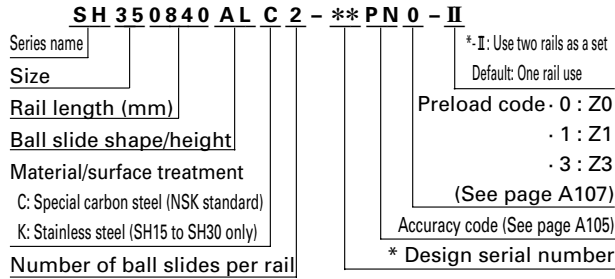

* Please note that we assign the design number, and omit the last code (II) that indicates a use of two rails as a set to finalize the reference number as product identification.

Front view of AL and BL types

Side view of AL type

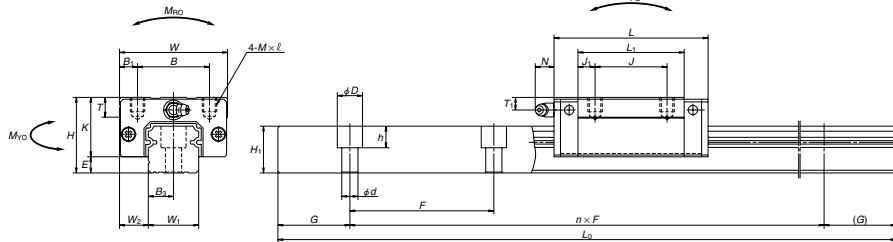

Side view of BL type

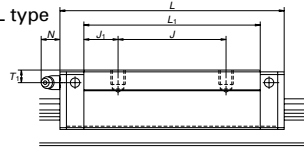

Model No.	Assembly			Ball slide												
	Height		Width	Length	Mounting hole					Grease fitting						
	H	E			W ₂	W	L	B	J	M x pitch x l	B ₁	L ₁	J ₁	K	T	Hole size
SH25AL SAH25AL SH25BL SAH25BL	36	7	12.5	48	79 107	35	35 50	M6x1x6	6.5	58 86	11.5 18	29	12	M6x0.75	6	11
SH30AL SAH30AL SH30BL SAH30BL	42	9	16	60	85.6 124.6	40	40 60	M8x1.25x8	10	59 98	9.5 19	33	14	M6x0.75	7	11
SH35AL SAH35AL SH35BL SAH35BL	48	9.5	18	70	109 143	50	50 72	M8x1.25x8	10	80 114	15 21	38.5	15	M6x0.75	8	11

Reference number for rail of interchangeable types
For regular rails (non-jointed rail)

Example:

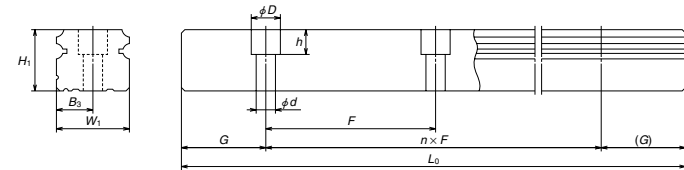
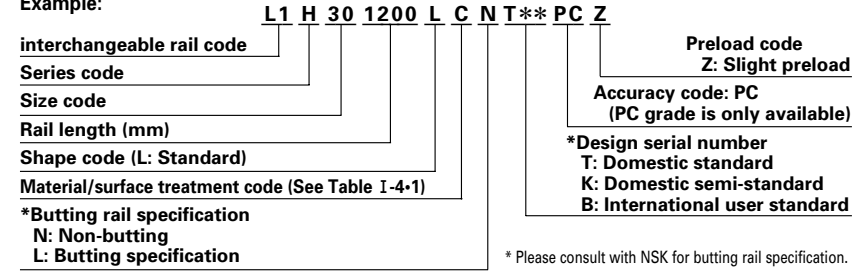

Reference number for ball slide of interchangeable types

Example:

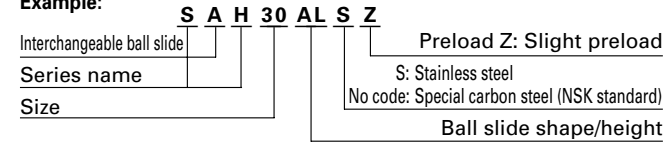

AL type

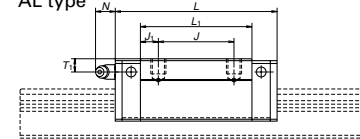

BL type

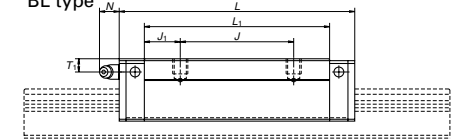

Rail							Basic load rating					Ball diameter D _w	Weight	
Width W ₁	Height H ₁	Pitch F	Mounting bolt hole d x D x h	B ₃	G (recomm. ended)	Max. length L _{0max} (1 for stainless)	Dynamic C (N)	Static C ₀ (N)	Static moment M _{Bo} , M _{po} , M _{vo} (N·m)				Ball slide (kg)	Rail (kg/m)
23	22	60	7x11x9	11.5	20	3 960 (3 500)	22 400 32 000	37 500 62 500	295 490	246 615	207 515	4.762	0.46 0.69	3.6
28	26	80	9x14x12	14	20	4 000 (3 500)	31 000 46 000	51 500 91 500	490 870	365 1 060	305 885	5.556	0.69 1.16	5.2
34	29	80	9x14x12	17	20	4 000	47 500 61 500	80 500 117 000	950 1 380	780 1 600	655 1 340	6.35	1.2 1.7	7.2

The basic dynamic load rating is a load that furnishes 50 km rating fatigue life; it is a vertical and constant load to the ball slide mounting surface.
When converting the basic dynamic load rating C to the dynamic load rating C₁₀₀ for 100 km rating fatigue life, divide the C by 1.26

SH-EL (High load type)
SH-GL (Super high load type)

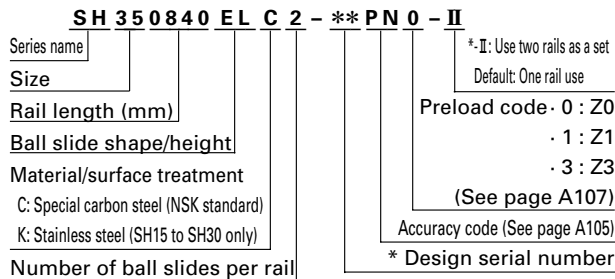

* Please note that we assign the design number, and omit the last code (II) that indicates a use of two rails as a set to finalize the reference number as product identification.

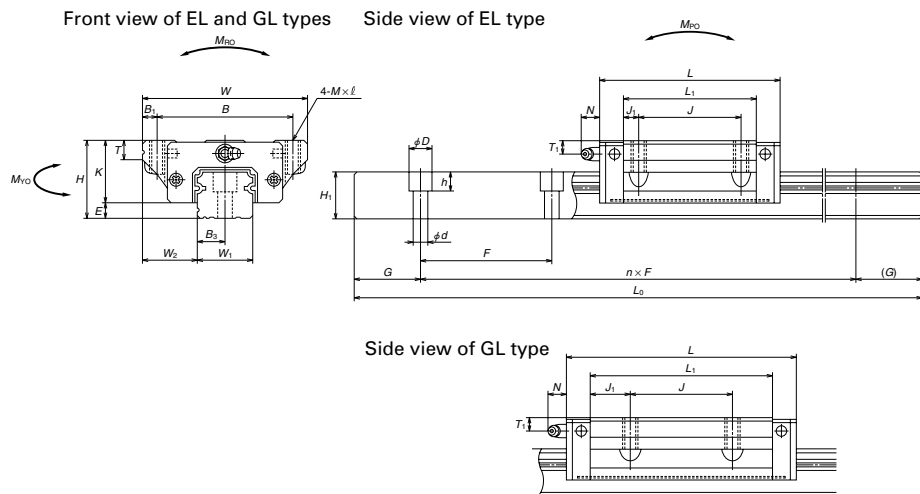

Model No.	Assembly			Ball slide												
	Height	Width	Length	Mounting hole					Grease fitting							
				H	E	W ₂	W	L	B	J	Mxpitchxℓ	B ₁	L ₁	J ₁	K	T
SH15EL SAH15EL SH15GL SAH15GL	24	4.6	16	47	55 74	38	30	M5x0.8x8	4.5	39 58	4.5 14	19.4	8	φ3	4.5	3.3
SH20EL SAH20EL SH20GL SAH20GL	30	5	21.5	63	69.8 91.8	53	40	M6x1x10	5	50 72	5 16	25	10	M6x0.75	5	11
SH25EL SAH25EL SH25GL SAH25GL	36	7	23.5	70	79 107	57	45	M8x1.25x16 (M8x1.25x12)	6.5	58 86	6.5 20.5	29	11 (12)	M6x0.75	6	11
SH30EL SAH30EL SH30GL SAH30GL	42	9	31	90	98.6 124.6	72	52	M10x1.5x18 (M10x1.5x15)	9	72 98	10 23	33	11 (15)	M6x0.75	7	11
SH35EL SAH35EL SH35GL SAH35GL	48	9.5	33	100	109 143	82	62	M10x1.5x20	9	80 114	9 26	38.5	12	M6x0.75	8	11
SH45EL SAH45EL SH45GL SAH45EL	60	14	37.5	120	139 171	100	80	M12x1.75x24	10	105 137	12.5 28.5	46	13	Rc1/8	10	13
SH55EL SAH55EL SH55GL SAH55GL	70	15	43.5	140	163 201	116	95	M14x2x28	12	126 164	15.5 34.5	55	15	Rc1/8	11	13

※Dimensions in () are applicable to stainless steel products.
※The external appearance of stainless steel ball slides differs from those of standard material ball slide.

Reference number for rail of interchangeable types

For regular rails (non-jointed rail)

Example:

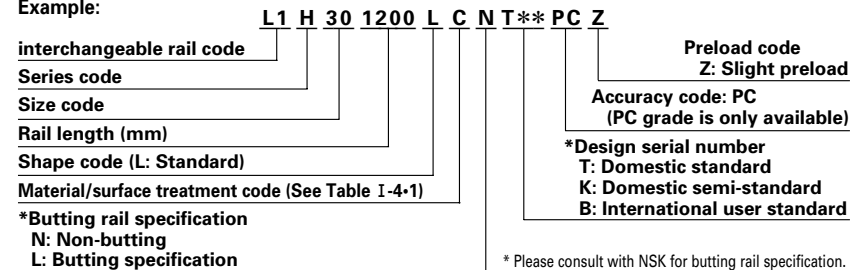

Reference number for ball slide of interchangeable types

Example:

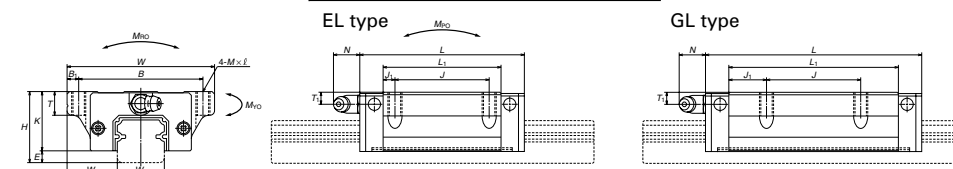
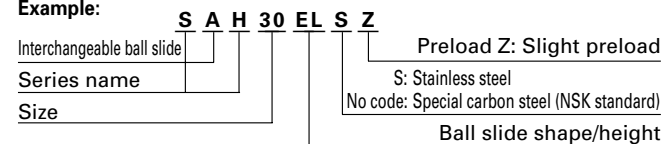

Rail										Basic load rating					Ball diameter	Weight	
Width	Height	Pitch	Mounting bolt hole	G	Max. length	Dynamic	Static	Static moment			D _w	Ball slide (kg)	Rail (kg/m)				
W ₁	H ₁	F	d×D×h	B ₃	L _{max} () for stainless	C	C ₀	M _{Ro}	M _{po}	M _{Vo}							
15	15	60	4.5×7.5×5.3	7.5	2 000 (1 800)	10 100 13 400	18 800 28 200	98 147	87 193	73 162	3.175	0.17 0.25	1.6				
20	18	60	6×9.5×8.5	10	20 (3 500)	16 300 21 600	29 600 44 500	199 298	167 360	141 305	3.968	0.45 0.65	2.6				
23	22	60	7×11×9	11.5	20 (3 500)	3 960 32 000	37 500 62 500	295 490	246 615	207 515	4.762	0.63 0.93	3.6				
28	26	80	9×14×12	14	20 (3 500)	35 500 46 000	63 000 91 500	600 870	540 1 060	450 885	5.556	1.2 1.6	5.2				
34	29	80	9×14×12	17	20	47 500 61 500	80 500 117 000	950 1 380	780 1 600	655 1 340	6.35	1.7 2.4	7.2				
45	38	105	14×20×17	22.5	22.5	76 500 94 500	128 000 175 000	1 970 2 680	1 550 2 760	1 300 2 320	7.937	3.0 3.9	12.3				
53	44	120	16×23×20	26.5	30	113 000 140 000	181 000 247 000	3 300 4 550	2 640 4 800	2 210 4 050	9.525	5.0 6.5	16.9				

The basic dynamic load rating is a load that furnishes 50 km rating fatigue life; it is a vertical and constant load to the ball slide mounting surface. When converting the basic dynamic load rating C to the dynamic load rating C₁₀₀ for 100 km rating fatigue life, divide the C by 1.26

SH Series

SH-EM (High load type)
SH-FL (Super high load type)
SH-HL (Super high load type)
SH-GM

SH 35 0840 FL C 2 - ** PN 0 - II

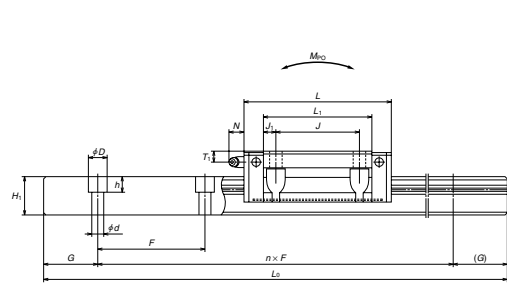
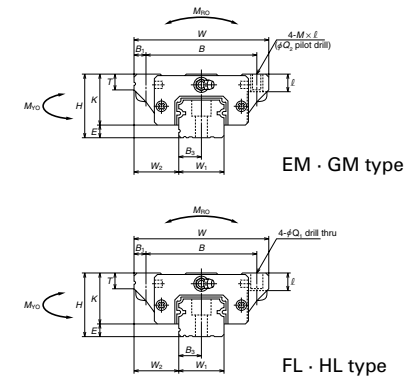
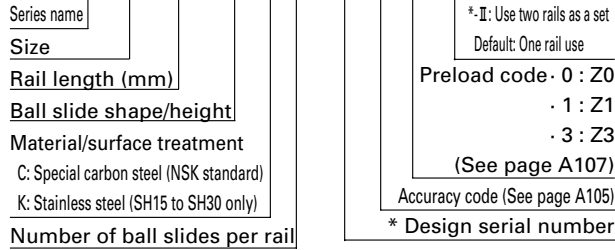

Model No.	Assembly			Ball slide													
	Height	Width	Length	Mounting hole										Grease fitting			
				H	E	W ₂	W	L	B	J	Mxpitchxℓ	Q ₂	B ₁	L ₁	J ₁	K	T
SH15FL SAH15FL SH15EM SAH15EM SH15HL SAH15HL SH15GM SAH15GM	24	4.6	16	47	55	38	30	4.5x7	4.4	4.5	39	4.5	19.4	8	φ3	4.5	3.3
SH20FL SAH20FL SH20EM SAH20EM SH20HL SAH20HL SH20GM SAH20GM	30	5	21.5	63	69.8	53	40	6x9.5	5.3	5	50	5	25	10	M6x0.75	5	11
SH25FL SAH25FL SH25EM SAH25EM SH25HL SAH25HL SH25GM SAH25GM	36	7	23.5	70	79	57	45	7x10(7x11.5) M8x1.25x10 (M8x1.25x11.5) 7x10(7x11.5) M8x1.25x10 (M8x1.25x11.5)	6.8	6.5	58	6.5	29	11 (12)	M6x0.75	6	11
SH30FL SAH30FL SH30EM SAH30EM SH30HL SAH30HL SH30GM SAH30GM	42	9	31	90	98.6	72	52	9x12(9x14.5) M10x1.5x12 (M10x1.5x14.5) 9x12(9x14.5) M10x1.5x12 (M10x1.5x14.5)	8.6	9	72	10	33	11 (15)	M6x0.75	7	11
SH35FL SAH35FL SH35EM SAH35EM SH35HL SAH35HL SH35GM SAH35GM	48	9.5	33	100	109	82	62	9x13 M10x1.5x13 9x13 M10x1.5x13	8.6	9	80	9	38.5	12	M6x0.75	8	11
SH45FL SAH45FL SH45EM SAH45EM SH45HL SAH45HL SH45GM SAH45GM	60	14	37.5	120	139	100	80	11x15 M12x1.75x15 11x15 M12x1.75x15	10.5	10	105	12.5	46	13	Rc1/8	10	13
SH55FL SAH55FL SH55EM SAH55EM SH55HL SAH55HL SH55GM SAH55GM	70	15	43.5	140	163	116	95	14x18 M14x2x18 14x18 M14x2x18	12.5	12	126	15.5	55	15	Rc1/8	11	13

A117 ※Dimensions in () are applicable to stainless steel products.
※The external appearance of stainless steel ball slides differs from those of standard material ball slide.

Reference number for rail of interchangeable types

For regular rails (non-jointed rail)

Example:

L1 H 30 1200 L C N T** PC Z

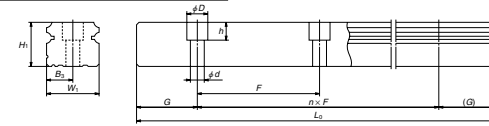
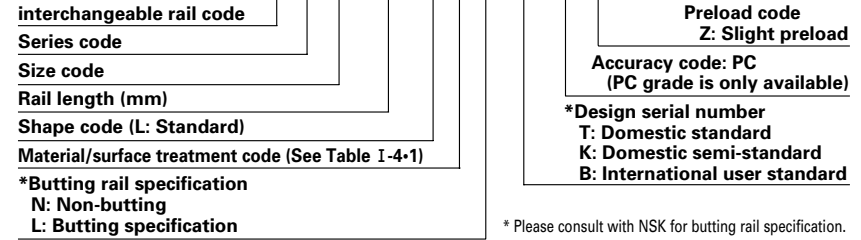

Reference number for ball slide of interchangeable types

Example:

Interchangeable ball slide S A H 30 FL S Z

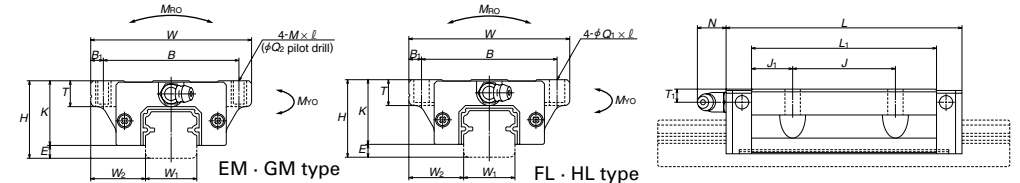
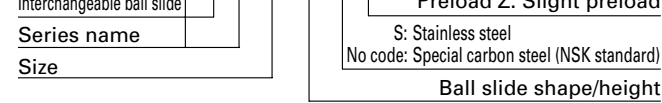

Rail							Basic load rating					Ball diameter	Weight	
Width	Height	Pitch	Mounting bolt hole	B ₃	G (recomm ended)	Max. length L _{0max} () for stainless	Dynamic C (N)	Static C ₀ (N)	Static moment (N-m)			D _w	Ball slide (kg)	Rail (kg/m)
W ₁	H ₁	F	d x D x h				C	C ₀	M _{Bo}	M _{Po}	M _{Vo}			
15	15	60	4.5x7.5x5.3	7.5	20	2000 (1800)	10100	18800	98	87	73	3.175	0.17	1.6
20	18	60	6x9.5x8.5	10	20	3960 (3500)	16300	29600	199	167	141	3.968	0.45	2.6
23	22	60	7x11x9	11.5	20	3960 (3500)	22400	37500	295	246	207	4.762	0.63	3.6
28	26	80	9x14x12	14	20	4000 (3500)	35500	63000	600	540	450	5.556	1.2	5.2
34	29	80	9x14x12	17	20	4000	47500	80500	950	780	655	6.35	1.7	7.2
45	38	105	14x20x17	22.5	22.5	3990	76500	128000	1970	1550	1300	7.937	3	12.3
53	44	120	16x23x20	26.5	30	3990	113000	181000	3000	2640	2210	9.525	5	16.9
							140000	247000	4550	4800	4050		6.5	

The basic dynamic load rating is a load that furnishes 50 km rating fatigue life; it is a vertical and constant load to the ball slide mounting surface. When converting the basic dynamic load rating C to the dynamic load rating C₁₀ for 100 km rating fatigue life, divide the C by 1.26