

special systems
piezogripper grippy III
fibergripper

- up to 300 µm gap motion
- variable gap shape design
- adjustable grip force
- high speed

applications:

- micro optics manipulation
- fiber optics assembly
- precision mounting and adjusting
- biological sample manipulation

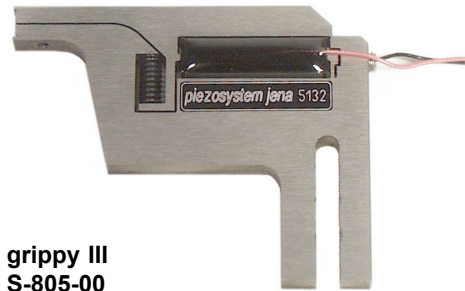

grippy III
S-805-00

The series of piezogripper was designed for micro systems handling applications. The accurate and high speed motion of a piezoactuator is transformed by the levered transmission of a solid state hinge joint to a 300 µm opening of the gripper gap.

Because of its compact dimensions, it is well suited for OEM applications.

All kinds of handling and manipulating small parts in research labs or industry are potential application fields for the piezogripper. The grip force depends on the used spring.

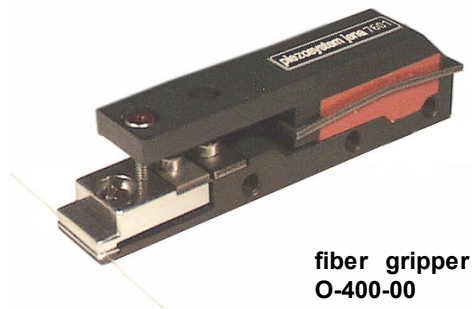

fiber gripper
O-400-00

technical data:

part no.	unit	S-805-00	O-400-00
free gap	mm	0.3	depending on fiber
free gripper motion	µm	275	300
operating voltage	V	-10 to +150	-10 to +150
capacitance (± 20%)	µF	0.8	1.7
temperature range	°C	-20 to 80	-20 to 80
dimensions	length	mm	54.5
	width	mm	38
	height	mm	7

options:

gripper gap shape per customer request

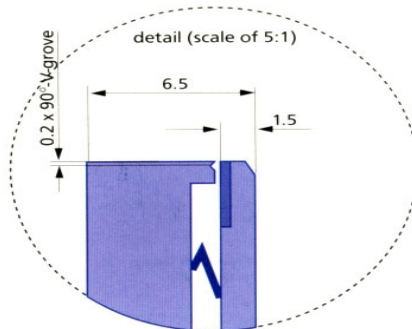
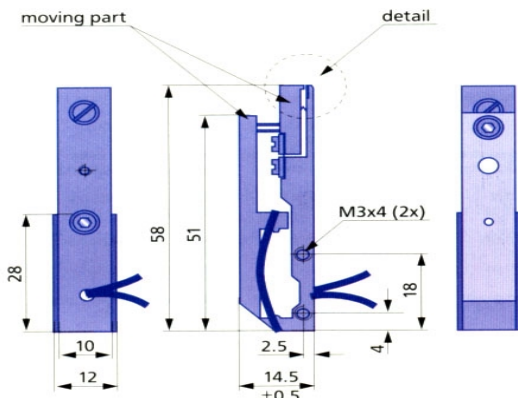

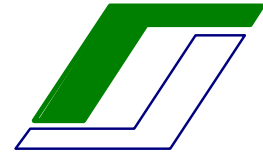

┌

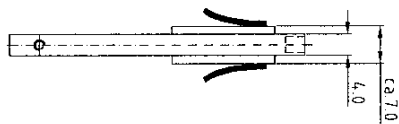
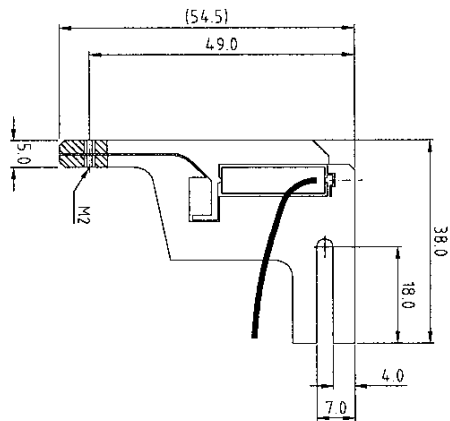

ORIGINAL

part.-no.	S-805-00	part.-name	Piezo Gripper 3
date	29. JAN. 2001	OK/Sign.	<i>W</i>
file name	PS80500	AZ 0	customers drawing piezosystem jena

└

piezosystem jena GmbH

Prüssingstraße 27 • 07745 Jena • HRB Gera 2823 • VAT ID-Nr. DE 150531409

Konten: Commerzbank BLZ 820 400 00, KTO 258 420 9 • Deutsche Bank BLZ 820 700 24, KTO 531 571 8

Tel. + 49 (3641) 66 88 0 • Fax +49 (3641) 66 88 66 • e-Mail info@piezोजना.com •

<http://www.piezोजना.com/>